

Hardware: Esp8266

O ESP8266 é um microcontrolador do fabricante chinês Espressif que inclui capacidade de comunicação por Wi-Fi. O chip chegou a cultura maker em agosto de 2014, com a ESP-01. Esta pequena placa permite que microcontroladores se conectem a uma rede sem fio fazendo conexões TCP/IP usando um conjunto de comandos Hayes.

Variantes

Os módulos ESP8266 são fornecidos numa ampla variedade de modelos, com diferenças perceptíveis principalmente no que tange à quantidade de I/Os disponíveis para acesso externo, e no tamanho do módulo.

Até o presente momento, “oficialmente” existem módulos numerados de ESP-01 até ESP-12. Os modelos ESP-01 até o ESP-11, com suas respectivas legendas indicadoras, são mostrados na Figura 2, em comparação com uma moeda no centro da imagem.



Esp8266 x Arduino Uno R3

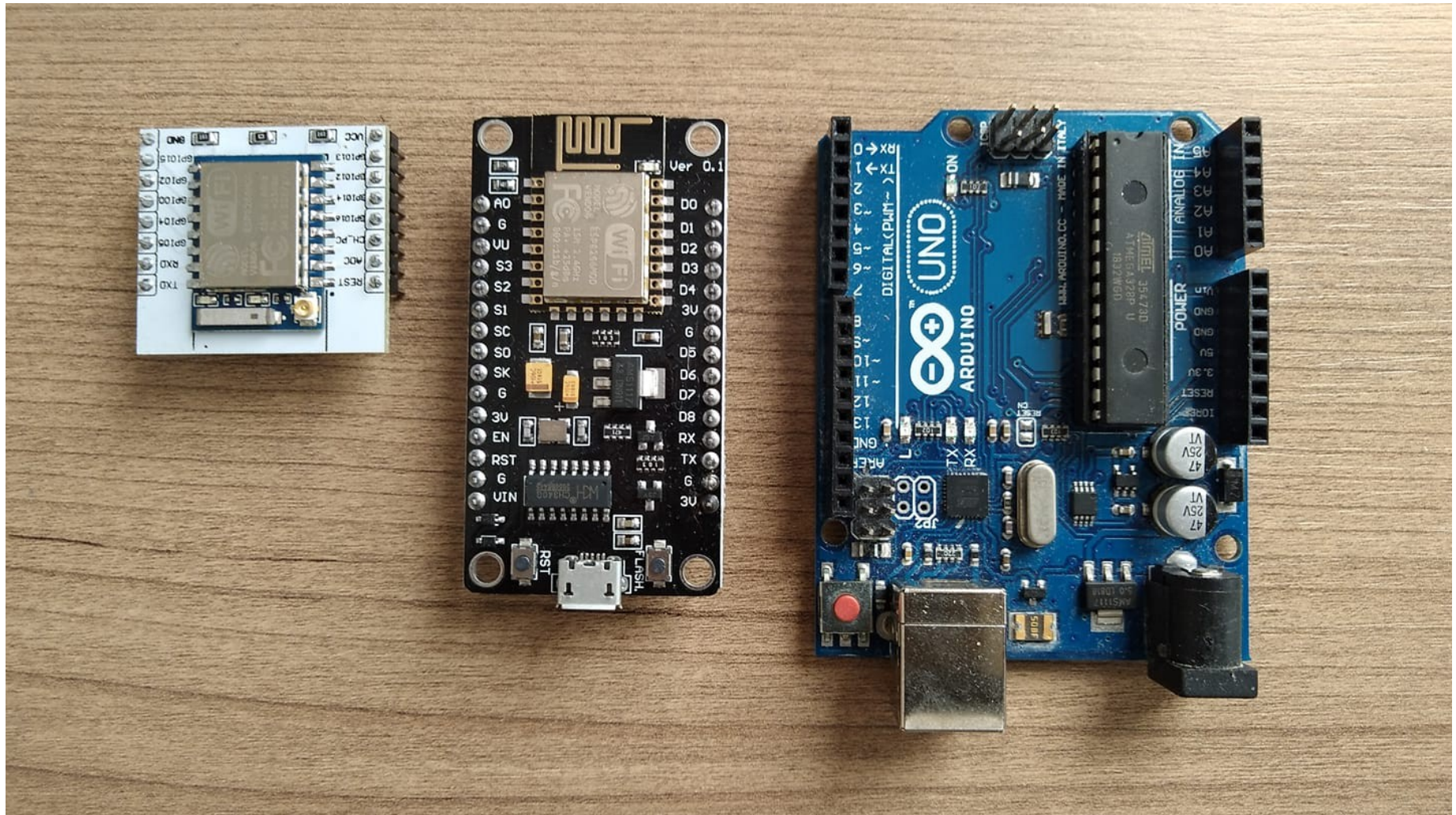

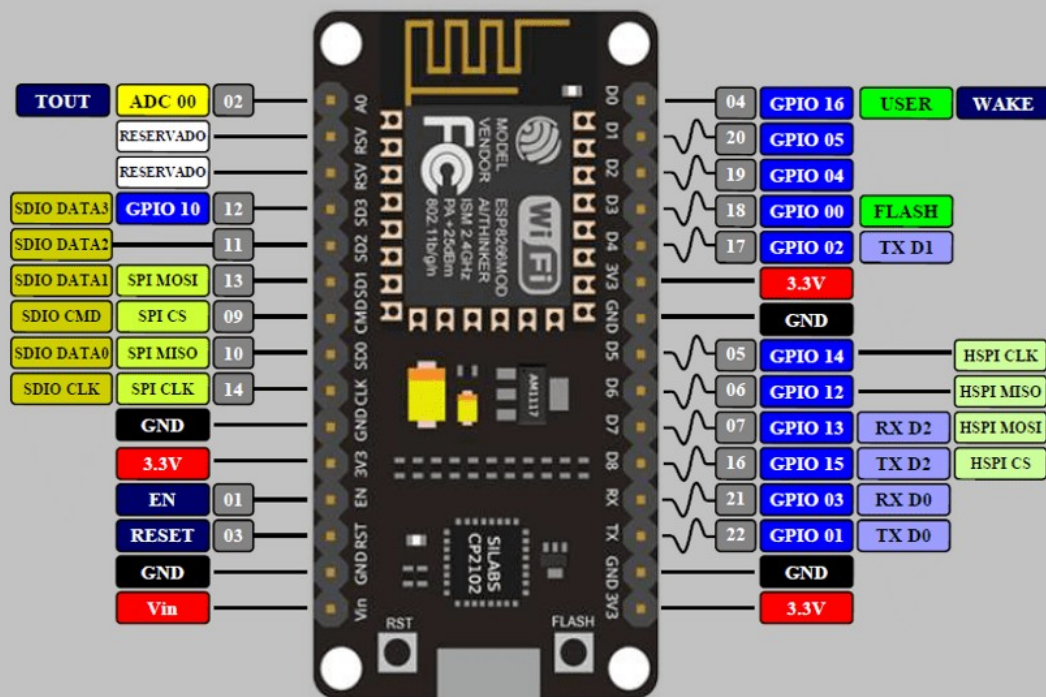



A placa ESP8266 gerencia a rotina de gerenciamento da leitura dos quatro sensores de solo, armazena os dados das leituras no banco de dados em nuvem;

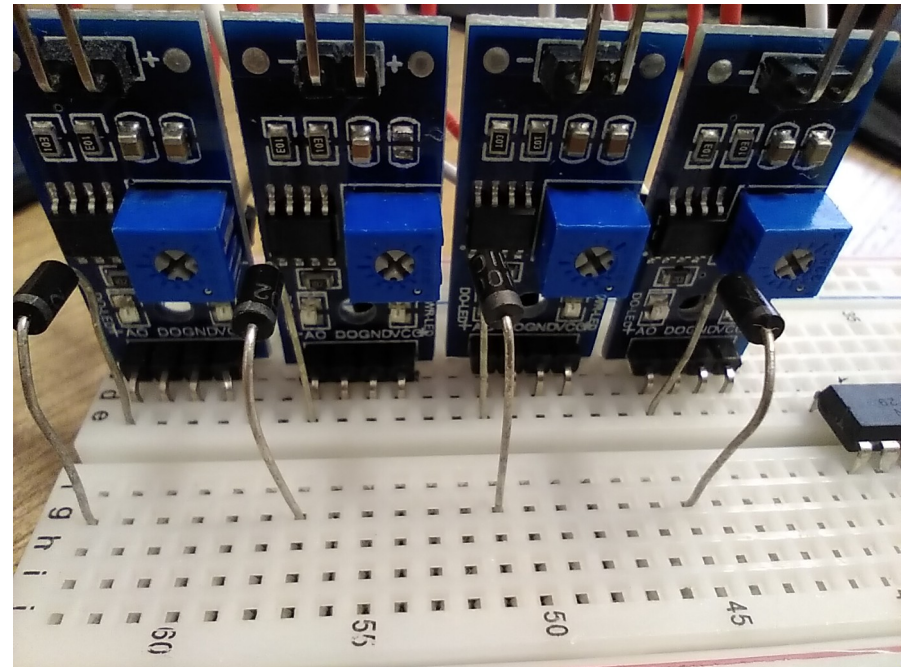
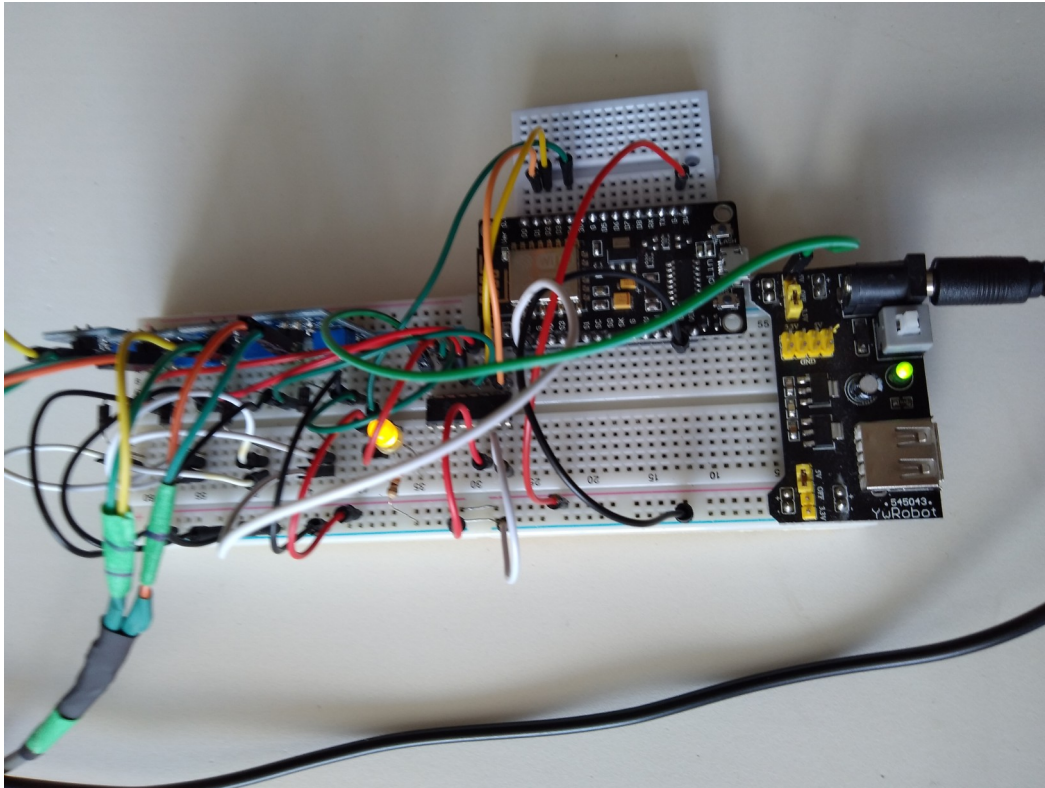



INSTITUTO
FEDERAL
Santa Catarina

Limitação do ESP x Desafio da eletrônica

O NodeMCU possui apenas uma porta analógica(A0) e o sistema de monitoramento precisa calcular a média das leituras de quatro sensores;
Solução: multiplexador CI74HC4052n

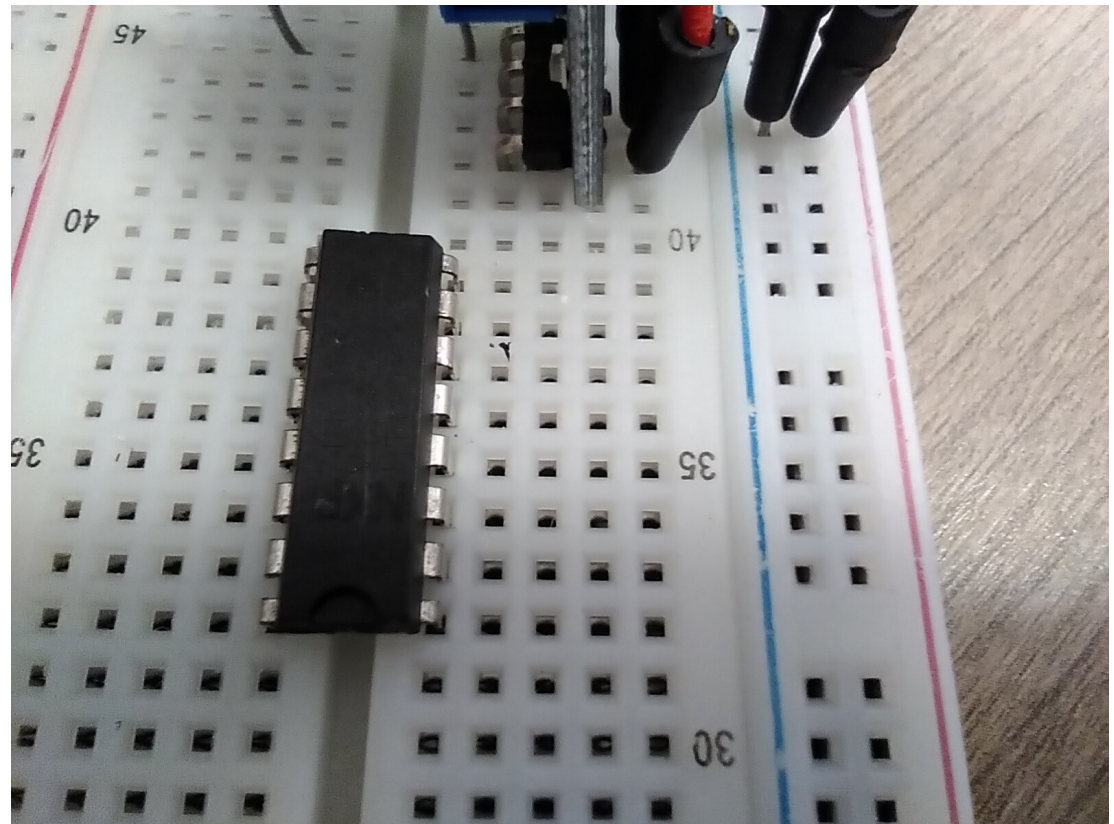
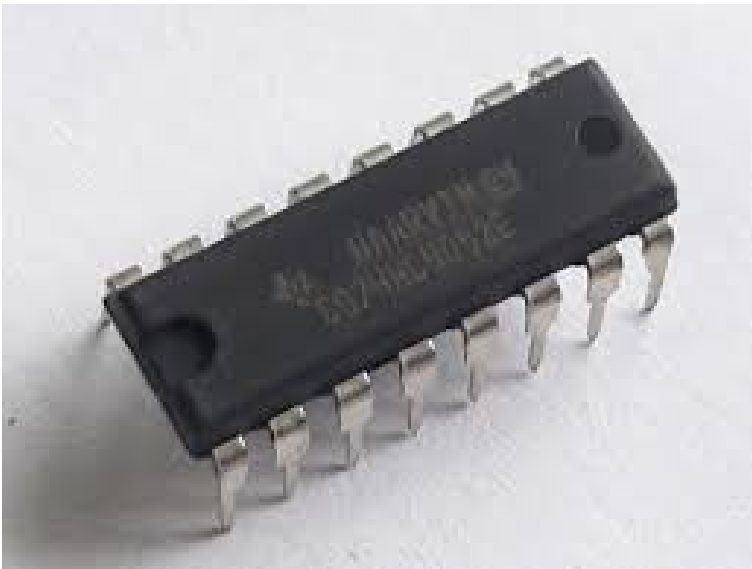



multiplex analogico hcf4052be

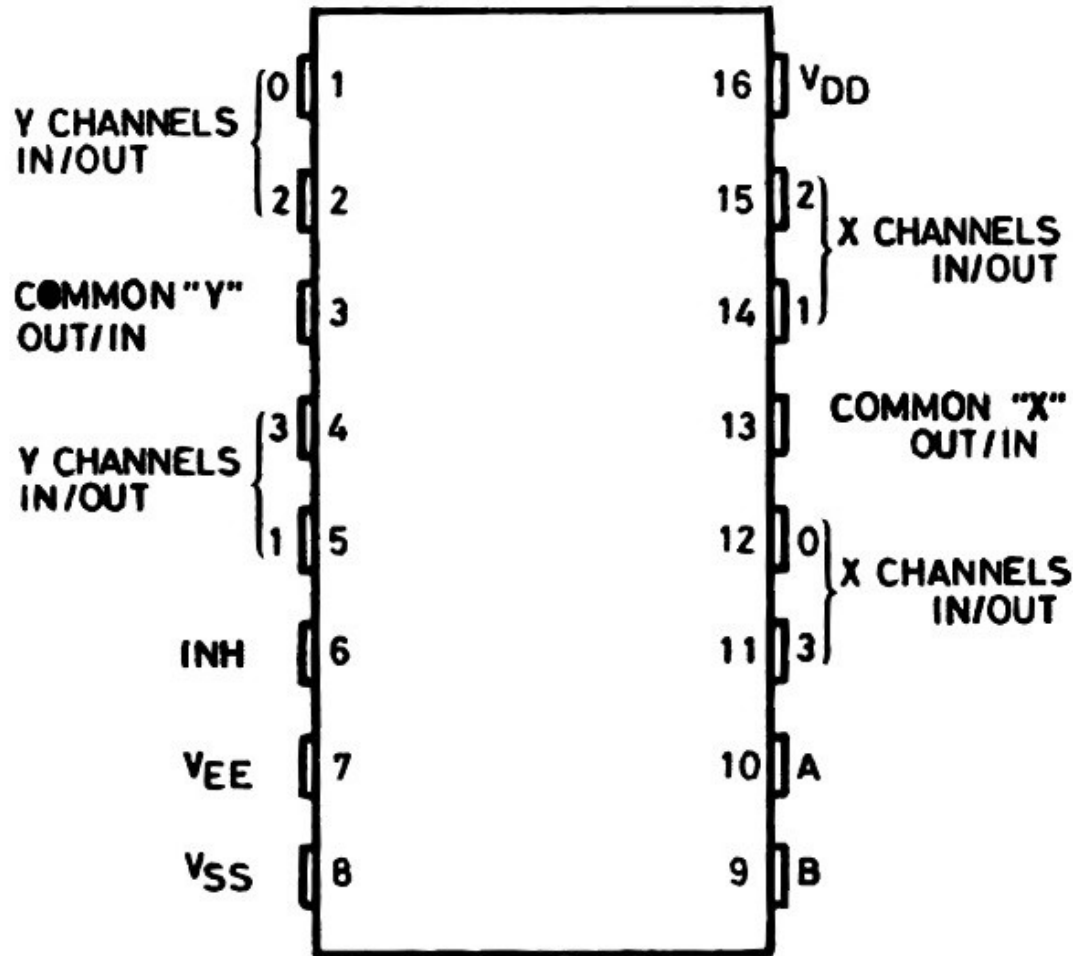

S-2506

PIN DESCRIPTION

PIN No	SYMBOL	NAME AND FUNCTION
10, 9	A, B	Binary Control Inputs
6	INH	Inhibit Inputs
12, 14, 15, 11	0X to 3X CHANNEL IN/OUT	X channels Input/Output
1, 5, 2, 4	0Y to 3Y CHANNEL IN/OUT	Y channels Input/Output
3	COM Y OUT/IN	Y Common Output/Input
13	COM X OUT/IN	X Common Output/Input
7	V _{EE}	Supply Voltage
8	V _{SS}	Negative Supply Voltage
16	V _{DD}	Positive Supply Voltage

TRUTH TABLE

INHIBIT	B	A	
0	0	0	0x, 0y
0	0	1	1x, 1y
0	1	0	2x, 2y
0	1	1	3x, 3y
1	X	X	NONE

X : Don't Care

Um pouco de programação: Código de ativação das portas da tabela verdade do multiplexador:

```
78  digitalWrite(sinal, HIGH);delay(1000); 91  digitalWrite(swa, 1);
79  digitalWrite(swa, 0);                  92  digitalWrite(swb, 0);
80  digitalWrite(swb, 0);                  93  delay(1000);
81  delay(1000);                           94  Sensor3=analogRead(A0);
82  Sensor1=analogRead(A0);                95  delay(1000);
83  delay(1000);                           96
84                                          97  digitalWrite(swa, 1);
85  digitalWrite(swa, 0);                  98  digitalWrite(swb, 1);
86  digitalWrite(swb, 1);                  99  delay(1000);
87  delay(1000);                           100 Sensor4=analogRead(A0);
88  Sensor2=analogRead(A0);                101 delay(1000);
89  delay(1000);                           102 digitalWrite(sinal, LOW);delay(1000);
```

Envio dos valores das leituras para o banco de dados remoto.

```
108 delay(1000);
109 // Criando uma conexao TCP
110 WiFiClient client;
111     const int httpPort = 80;
112     if (!client.connect(host, httpPort)) {
113         return;}
114 // Enviando dados dos sensor para o banco de dados.
115     client.print(String("POST /sacada_insert.php?Sensor1=") + (Sensor1) +
116         "&Sensor2=" + (Sensor2) +
117         "&Sensor3=" + (Sensor3) +
118         "&Sensor4=" + (Sensor4) +
119         " HTTP/1.1\r\n" + "Host: " + host + "\r\n" + "Connection: close\r\n\r\n");
120     espera=(random(90,120)*1000);
121     delay(espera);
```





Sistema de envio ao banco de dados

Através da conexão WiFi nativa do ESP8266 é possível enviar os valores das leituras para o banco de dados remoto.

No ESP8266 existe o algoritmo que gerencia as leituras e envia os dados ao servidor remoto através da programação em c.

No Servidor existe o arquivo php que faz a validação dos dados enviados e insere no banco de dados

- +  public_ftp
- +  public_html
- +  sacada904.migueldebarba.com.br

Pasta com o arquivos de recebimento dos dados pelo ESP8266 e arquivo de consulta ao banco de dados.

 sacada_consulta.php	4,12 KB	31 de dez. de 2020 11:52	application/x-httpd-php
 sacada_insert.php	1,56 KB	15 de set. de 2020 19:50	application/x-httpd-php

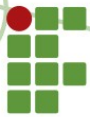

```
1 k?php
2
3 //Código de conexão ao BD
4
5 error_reporting(E_ALL);
6 ini_set('display_errors', 'On');
7
8 //$servername = "www.sacada904.migueldebarba.com.br";
9 $servername = "localhost";
10
11 $username = "miguelde_castellone";
12 $password = " ";
13 $dbname = "miguelde_sacada904";
14
15 $conectaBD = new mysqli($servername, $username, $password,$dbname);
16
```

```
17 //Variáveis recebidas pela URL
18
19 $grava=false;
20
21 $Sensor1 = $_GET['Sensor1'];
22 $Sensor2 = $_GET['Sensor2'];
23 $Sensor3 = $_GET['Sensor3'];
24 $Sensor4 = $_GET['Sensor4'];
25
26 $DataLeitura = date('Y/m/d');
27 $HoraLeitura = date('H:i:s');
28
29
30 $h = "3"; //HORAS DO FUSO ((BRASÍLIA = -3) COLOCA-SE SEM O SINAL -).
31 $hm = $h * 60;
32 $ms = $hm * 60;
33 //COLOCA-SE O SINAL DO FUSO ((BRASÍLIA = -3) SINAL -) ANTES DO ($ms). DATA
34 $gmdata = gmdate("Y/m/d", time()-($ms));
35
36 //COLOCA-SE O SINAL DO FUSO ((BRASÍLIA = -3) SINAL -) ANTES DO ($ms). HORA
37 $gmhora = gmdate("g:i", time()-($ms));
38
39 date_default_timezone_set('America/Sao_Paulo');
```

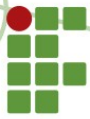





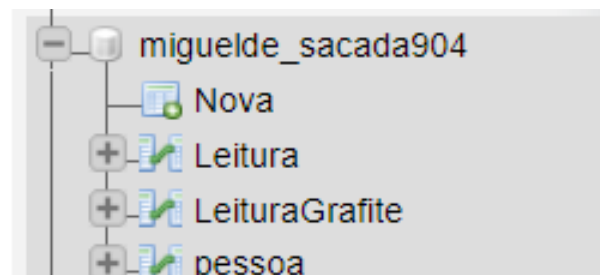































```
41 //Insero no Banco de Dados, usando Prepared Statements.
42
43 $sql="SELECT Sensor1,Sensor2,Sensor3,Sensor4 FROM Leitura
44 ";
45
46 $result = $conectaBD->query($sql);
47
48 $row = $result->fetch_assoc();
49 $grava=true;
50 //if ($row['temperatura']==0 or $row['umidade']==0) $grava=false;
51 //if ($row['temperatura']!=$temperatura) $grava=true;
52
53 if ($grava){
54 $sql="INSERT INTO Leitura (DataLeitura,HoraLeitura,Sensor1,Sensor2,Sensor3,Sensor4) VALUES (?, ?, ?, ?, ?, ?)";
55 $stmt = $conectaBD->prepare($sql);
56 $stmt->bind_param('ssssss', $gmdata, $gmhora, $Sensor1, $Sensor2, $Sensor3, $Sensor4);
57
58 $stmt->execute();
59 $grava=false;
60 echo 'Dados gravados com sucesso!';
61 }
```

Banco de dados com as tabelas de gerenciamento.



+ Opções

		IdLeitura	HoraLeitura	DataLeitura	Sensor1	Sensor2	Sensor3	Sensor4	UmidadeAr	TemperaturaAr	Luz
<input type="checkbox"/>	 Edita  Copiar  Apagar	105425	09:28:00	2021-02-25	674	520	523	677	NULL	NULL	NULL
<input type="checkbox"/>	 Edita  Copiar  Apagar	105424	09:25:00	2021-02-25	675	588	532	740	NULL	NULL	NULL
<input type="checkbox"/>	 Edita  Copiar  Apagar	105423	09:24:00	2021-02-25	638	546	533	745	NULL	NULL	NULL
<input type="checkbox"/>	 Edita  Copiar  Apagar	105422	09:22:00	2021-02-25	634	602	535	746	NULL	NULL	NULL
<input type="checkbox"/>	 Edita  Copiar  Apagar	105421	09:20:00	2021-02-25	642	600	532	747	NULL	NULL	NULL
<input type="checkbox"/>	 Edita  Copiar  Apagar	105420	09:18:00	2021-02-25	677	586	585	737	NULL	NULL	NULL
<input type="checkbox"/>	 Edita  Copiar  Apagar	105419	09:16:00	2021-02-25	674	579	576	728	NULL	NULL	NULL
<input type="checkbox"/>	 Edita  Copiar  Apagar	105418	09:14:00	2021-02-25	681	584	519	735	NULL	NULL	NULL
<input type="checkbox"/>	 Edita  Copiar  Apagar	105417	09:12:00	2021-02-25	608	581	530	740	NULL	NULL	NULL
<input type="checkbox"/>	 Edita  Copiar  Apagar	105416	09:10:00	2021-02-25	684	537	588	747	NULL	NULL	NULL
<input type="checkbox"/>	 Edita  Copiar  Apagar	105415	09:08:00	2021-02-25	618	524	573	670	NULL	NULL	NULL
<input type="checkbox"/>	 Edita  Copiar  Apagar	105414	09:07:00	2021-02-25	612	578	582	736	NULL	NULL	NULL

Visualização das leituras Através do endereço eletrônico

<http://sacada904.migueldebarba.com.br/>

UMIDADE DO SOLO

Monitoramento da umidade através da plataforma ESP8266 V1.0 inserindo os dados na web.



Informe a data inicial: 

Informe a data final: 

Consultar



INSTITUTO
FEDERAL
Santa Catarina

Os dois sistemas atuais

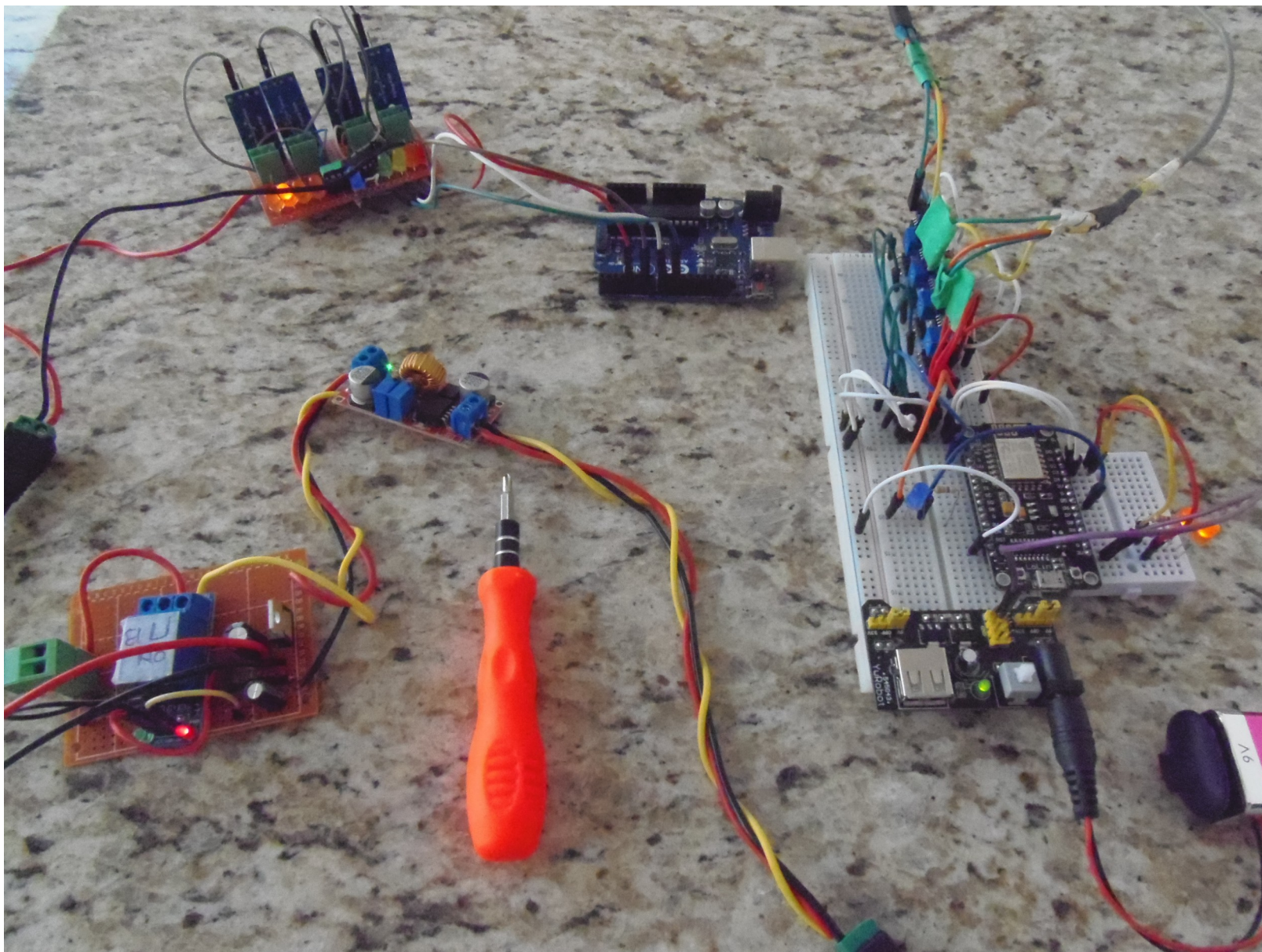



INSTITUTO
FEDERAL
Santa Catarina

Futuro sistema unificado

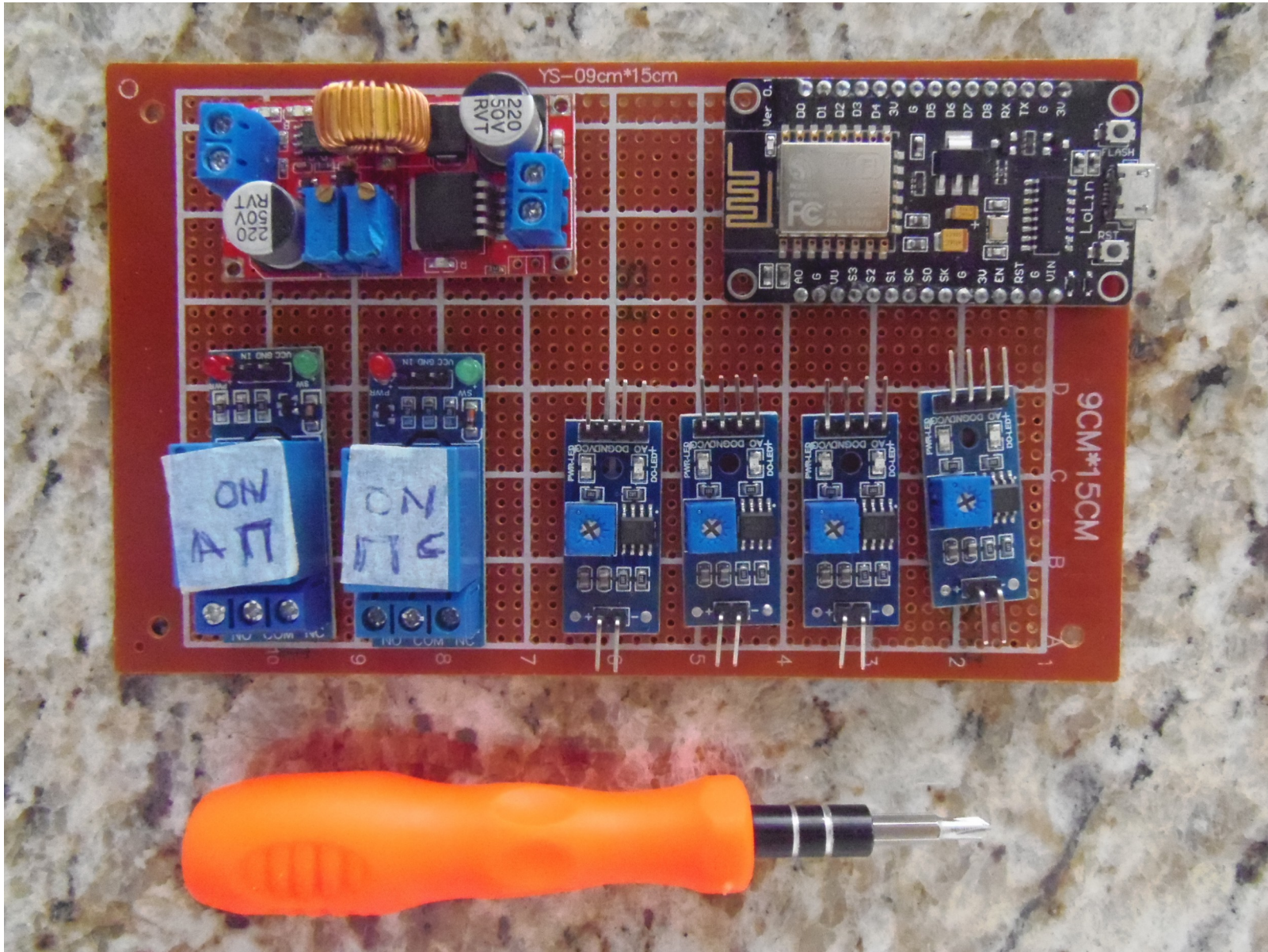



Novos desafios.

Através da placa de circuito impresso é possível unificar os dois sistemas em apenas um, facilitando assim a instalação e a diminuição da quantidade de fios que existem atualmente.

Após a unificação dos sistemas, a próxima etapa será miniaturizar os controladores facilitando a instalação dos mesmos perto dos vasos da horta e a eliminação dos fios através da utilização de rádio frequência para envio das leituras até a base e desta para o servidor remoto.

A miniaturização do controlador da irrigação está em fase de testes. Ainda existem diversos problemas e contratempos de falha de circuito, problema com aquecimento de componentes devido ao consumo de corrente dentre outros.



**INSTITUTO
FEDERAL**
Santa Catarina

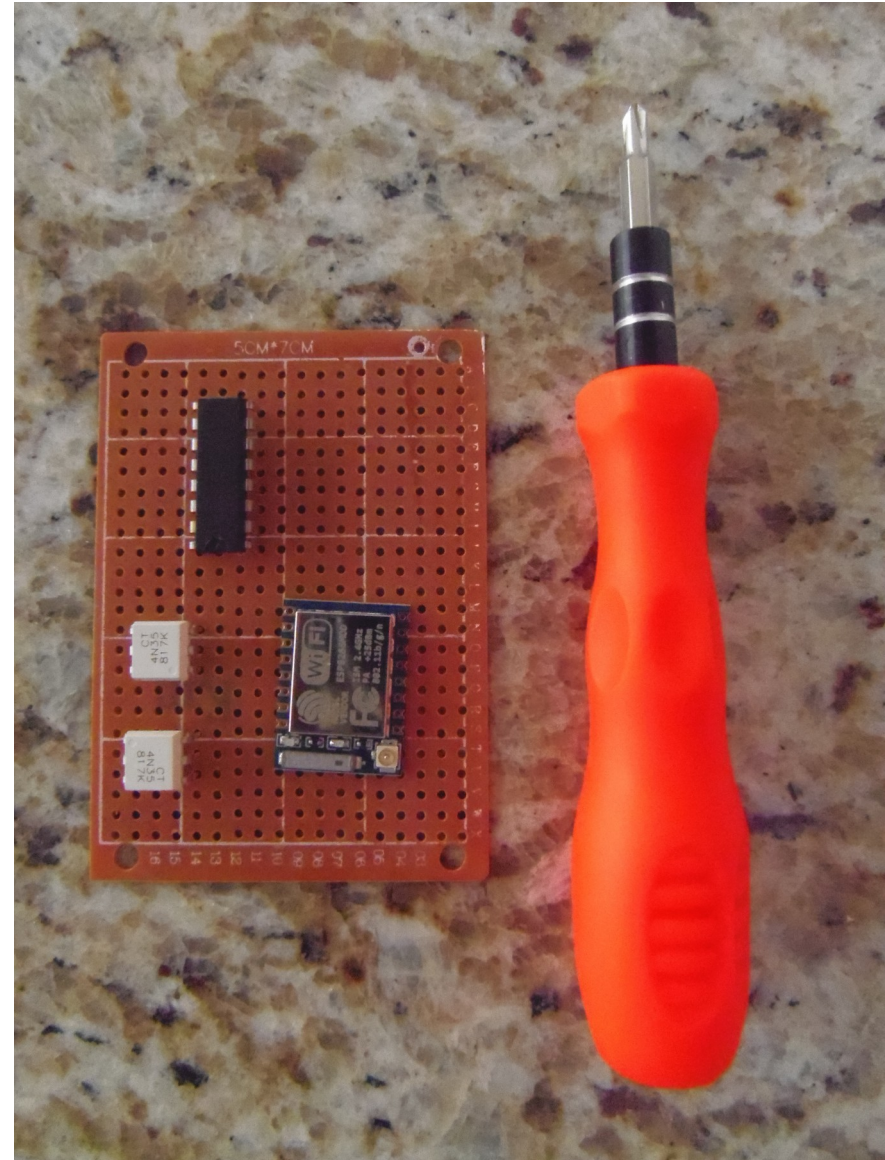
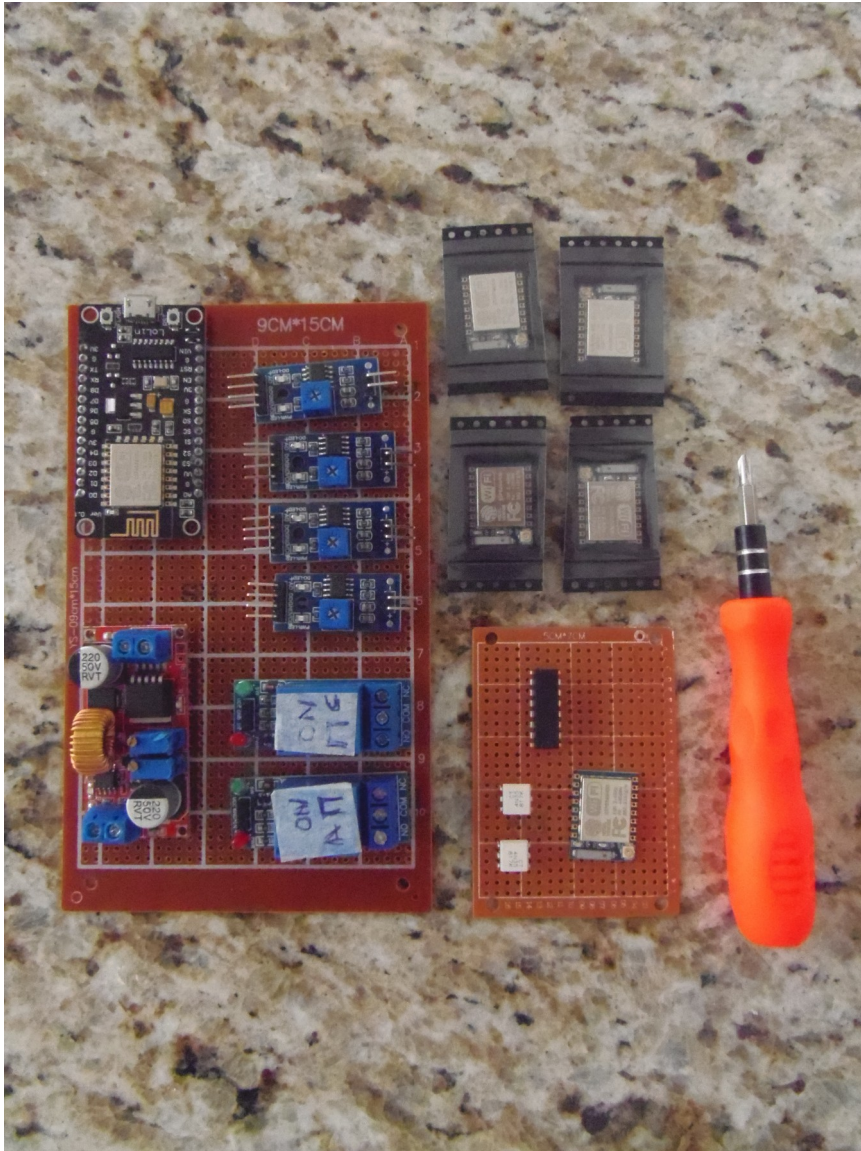

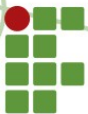

**INSTITUTO
FEDERAL**
Santa Catarina

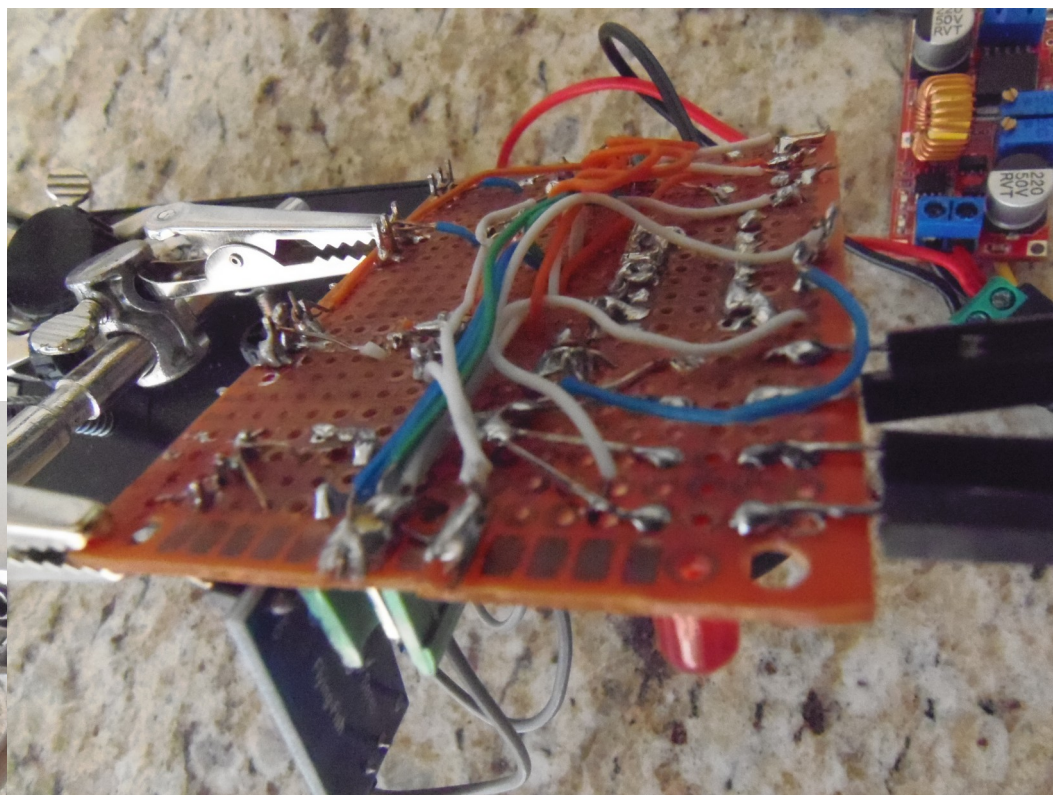
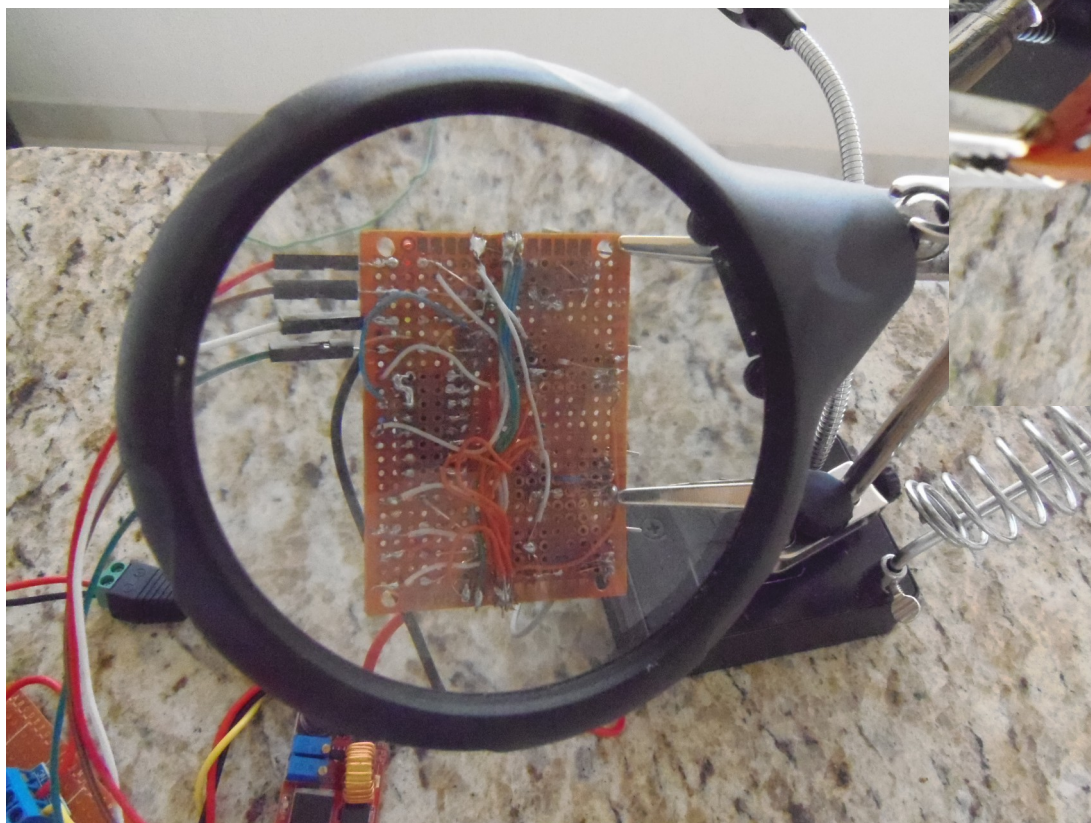

PiscaLed CI 74hc4052n

O objetivo deste circuito é acionar 4 leds na sequência utilizando apenas duas portas digitais do ESP8266.

O multiplexador CI74hc4052n fará a conversão dos sinais de entrada através dos pinos 9 e 10 para acionar os pinos de saída 0-1-2-3 através da tabela verdade a seguir:

multiplex analogico hcf4052be

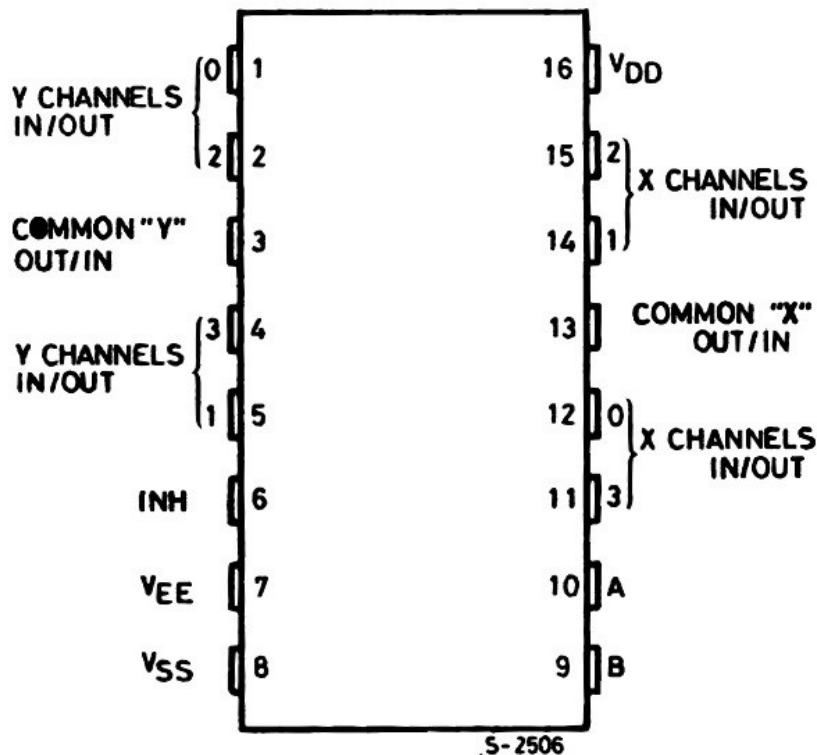

PIN DESCRIPTION

PIN No	SYMBOL	NAME AND FUNCTION
10, 9	A, B	Binary Control Inputs
6	INH	Inhibit Inputs
12, 14, 15, 11	0X to 3X CHANNEL IN/OUT	X channels Input/Output
1, 5, 2, 4	0Y to 3Y CHANNEL IN/OUT	Y channels Input/Output
3	COM Y OUT/IN	Y Common Output/Input
13	COM X OUT/IN	X Common Output/Input
7	V _{EE}	Supply Voltage
8	V _{SS}	Negative Supply Voltage
16	V _{DD}	Positive Supply Voltage

TRUTH TABLE

INHIBIT	B	A	
0	0	0	0x, 0y
0	0	1	1x, 1y
0	1	0	2x, 2y
0	1	1	3x, 3y
1	X	X	NONE

X : Don't Care



	A	B	C	D	E	F	G	H	I	J
2	1	2	3	4	5	6	7	8	10	9
3										
4	X		io				GND	GND	0	0
5					X				0	1
6		X							1	0
7					X				1	1
8										
9	16	15	14	13	12	11	10	9		
10	VCC			io	X		0	0		
11			X				0	1		
12		X					1	0		
13						X	1	1		

74LV4052

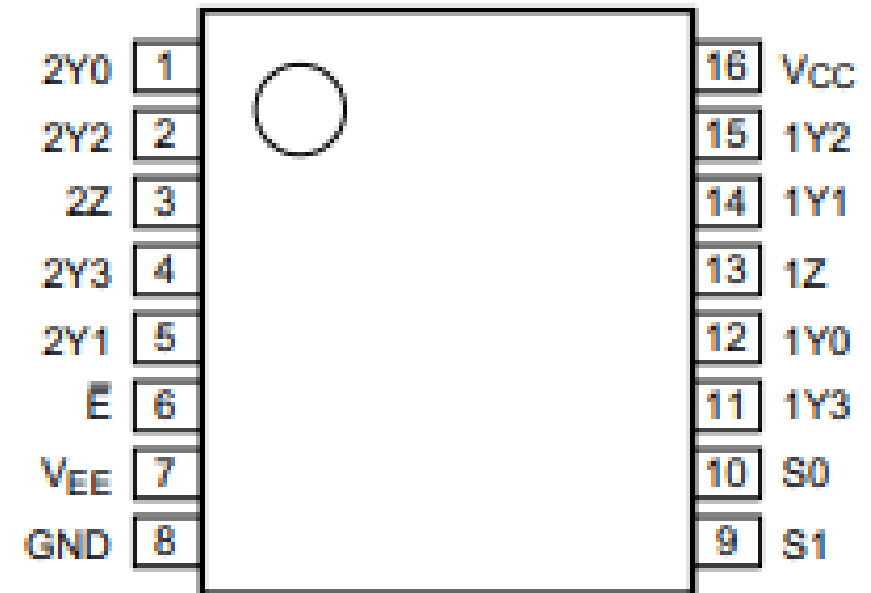

aaa-008171



INSTITUTO
FEDERAL

Sar

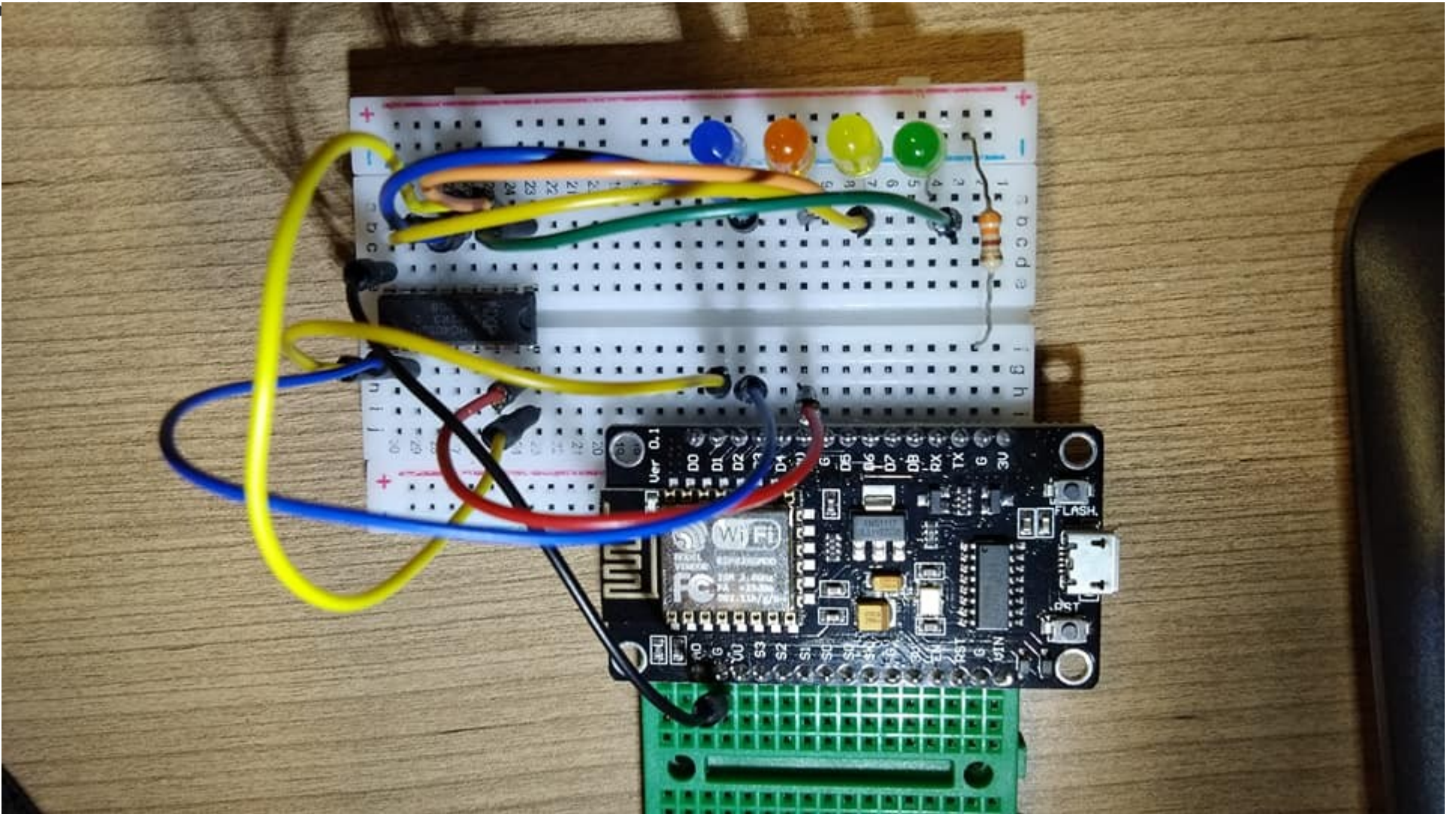

IN
F
Sa

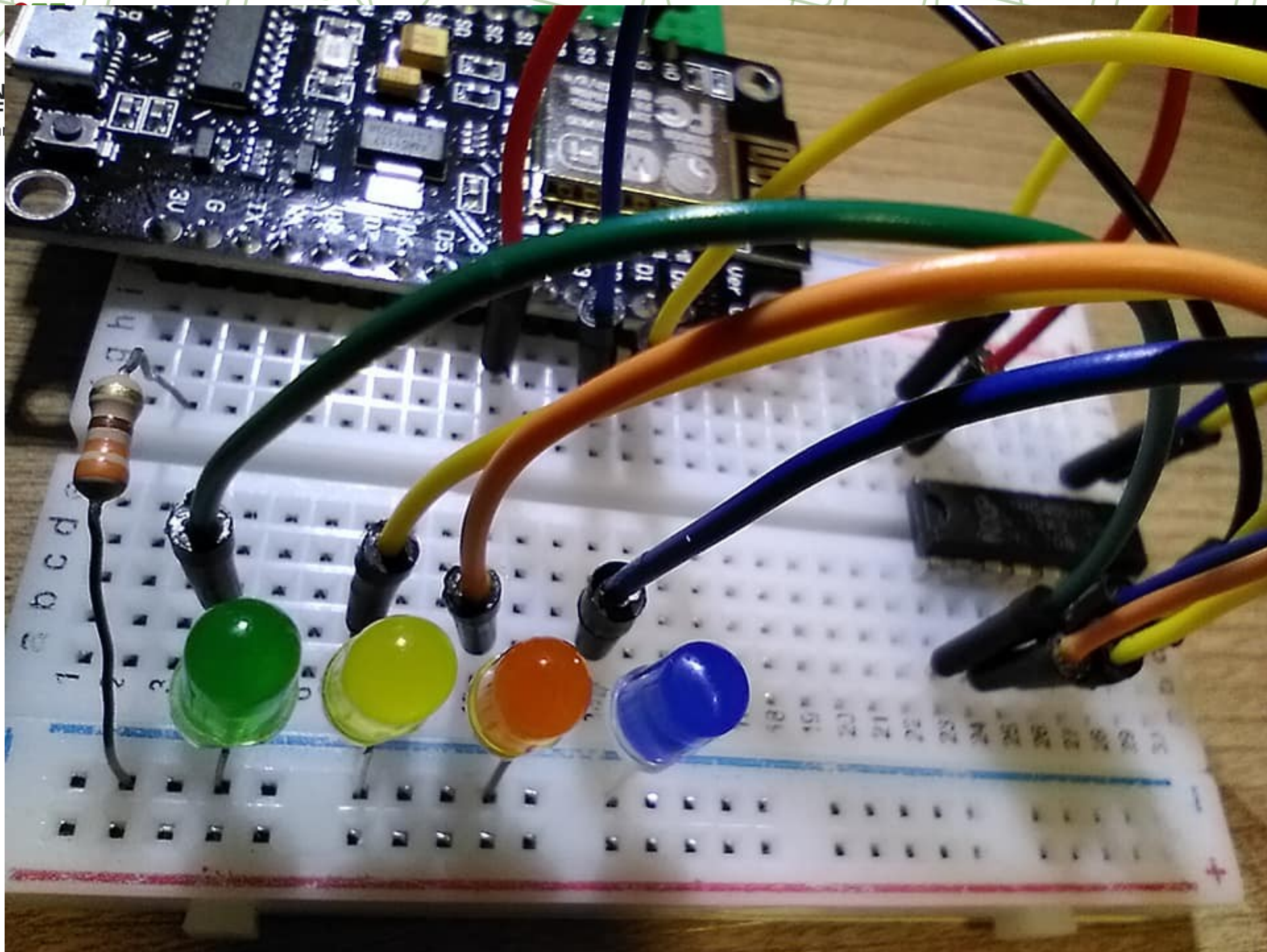



	A	B	C	D	E	F	G	H	I	J		
2	1	2	3	4	5	6	7	8	10	9		
3												
4	X		io				GND	GND	0	0		
5						X					0	1
6		X									1	0
7				X					1	1		
8												
9	16	15	14	13	12	11	10	9				
10	VCC			io	X		0	0				
11			X					0	1			
12		X						1	0			
13						X		1	1			

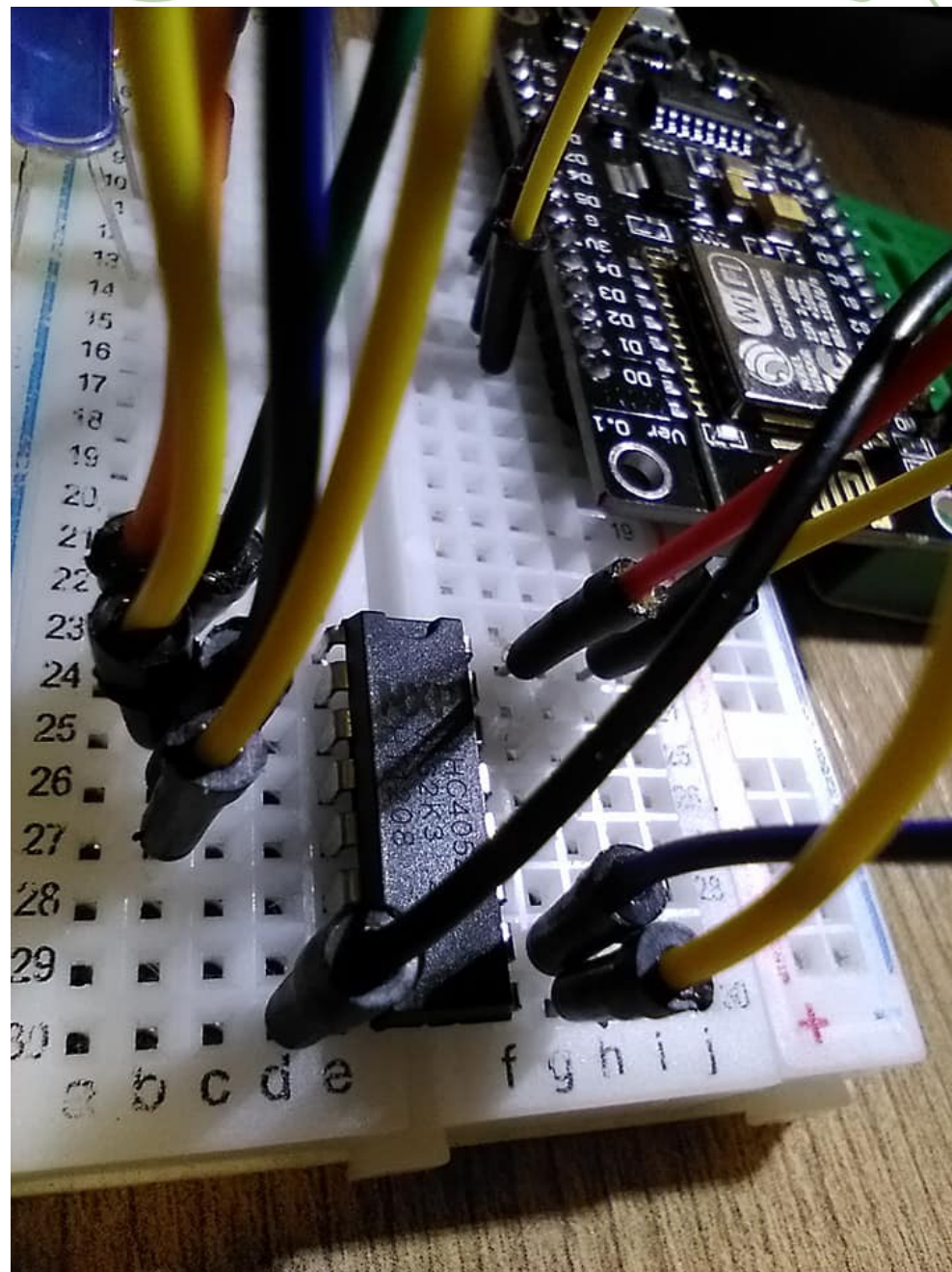



sketch

ci704052_ESP8266PiscaLed.ino §

```
1 #define D0      16
2 #define D1      4
3 #define D2      5
4 #define D3      0
5 #define D4      2
6 #define D5      14
7 #define D6      12
8 #define D7      13
9 #define D8      15
10 #define D9      3
11 #define D10     1
12
13 int pino9=4;
14 int pino10=5;
15 int ladox=12;
```

```
18 void setup() {
19     Serial.begin(115200);
20
21     // Define pinos como Saida
22
23     pinMode(pino9, OUTPUT);
24     pinMode(pino10, OUTPUT);
25     pinMode(ladox, OUTPUT);
26     pinMode(ladoy, OUTPUT);
27
28 }
```



```
29 void loop() {  
30     int Espera=1000;  
31     digitalWrite(ladoy, LOW);  
32     delay(Espera);  
33     digitalWrite(ladoy, HIGH);  
34     digitalWrite(pino9, LOW);  
35     digitalWrite(pino10, LOW);  
36     delay(Espera);  
37     digitalWrite(pino9, HIGH);  
38     digitalWrite(pino10, LOW);  
39     delay(Espera);  
40     digitalWrite(pino9, LOW);  
41     digitalWrite(pino10, HIGH);  
42     delay(Espera);  
43     digitalWrite(pino9, HIGH);  
44     digitalWrite(pino10, HIGH);  
45     delay(Espera);  
46 }
```